

873Y

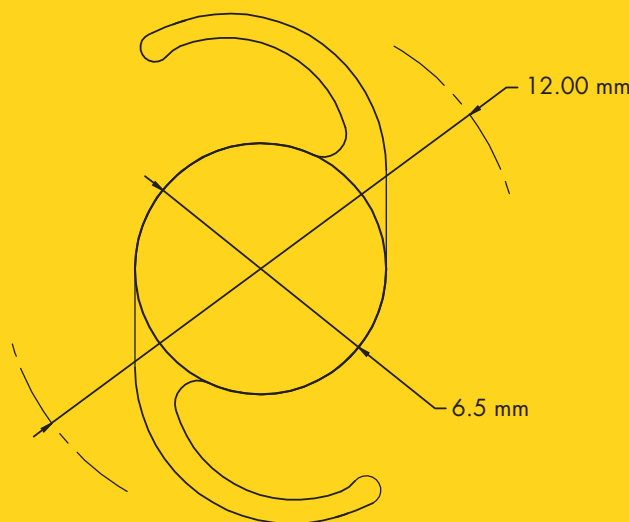
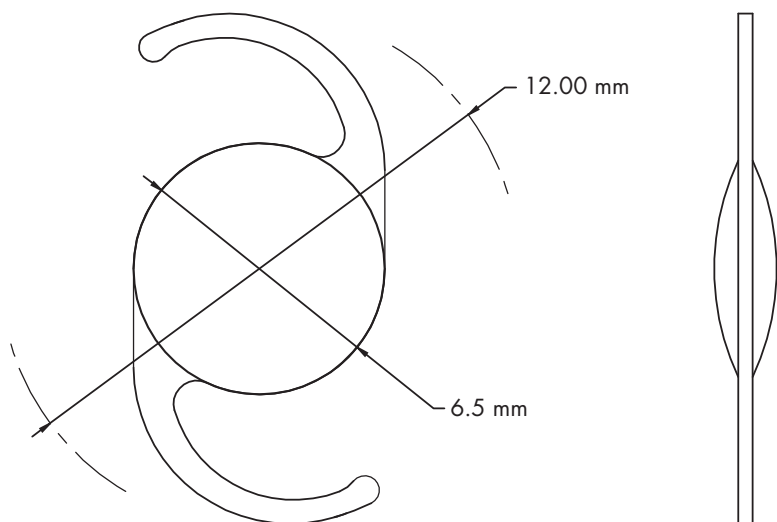

Indications: Posterior chamber/cataract surgery

Additional Specifications

Not available in the United States

Optical hydrophilic acrylic with UV blocker (26% water content)

Diopter range= 0.0 to 42.0

0.0 to 10.0 x 1.0 increments

10.0 to 30.0 x 0.5 increments

30.0 to 42.0 x 1.0 increments

Refractive Index=1.457 @ 35°C (fully hydrated)

Light transmission > 90%

Equal biconvex aspheric design

Square optic edge

Incision size - 2.8 mm

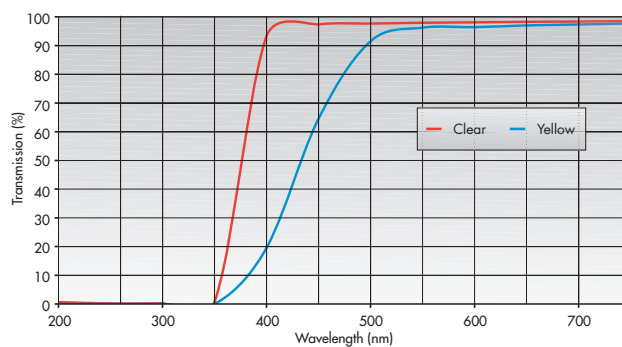

CERTIFIED
ISO 13485



TEKIA